



Stock shapes
Direct forming

TECASINT Compendium



4	TECASINT in application
5	Product families
7	Direct forming process
10	Mechanical properties
14	Thermal/Electrical properties
15	Tribological properties
16	Resistance to environmental influences
17	Flammability, weather resistance
18	Chemical resistance
19	Purity
20	FAQs
21	Machining guidelines, bonding
23	Standard shapes dimensions

Parts and shapes made of TECASINT have excellent long-term thermal stability. The broad temperature application spectrum of these materials ranges from -270 °C to +300 °C. Even when heated briefly to 350 °C, TECASINT materials will not melt or soften. Strength, dimensional stability and creep strength remain high under mechanical stress even during long-term usage.

The trend towards space and weight saving in modern engineering applications results in increased thermal and wear resistance expectations in the materials used. The characteristic profile of polyimides addresses these stringent demands with outstanding success:

- TECASINT from Ensinger is a range of non-melting high-temperature polyimides which are characterized by the following properties:
- High strength over a wide temperature range from -270 °C to +300 °C
 - Long-term thermal stability up to 300 °C
 - HDT/A up to 470 °C
 - Excellent electrical insulation properties
 - High compressive and creep strength
 - High radiation resistance
 - High purity, low outgassing in vacuum in accordance with ESA regulation ECSS-Q-70-02
 - Minimal thermal expansion
 - Minimal thermal conductivity
 - Excellent friction and wear properties – even without lubrication
 - Good chemical resistance to acids, fats and solvents
 - Good cryogenic properties
 - Inherently flame resistant (UL 94 V0)

TECASINT high-temperature polyimides are used in demanding applications which are beyond the capability of other materials. Key benefits include extreme temperature resistance, good mechanical load capacity, weight saving, good sliding and wear properties and good thermal and electrical insulation. This test socket made of TECASINT 4011 is used in the semiconductor industry and combines low thermal expansion with high dimensional stability and temperature resistance.

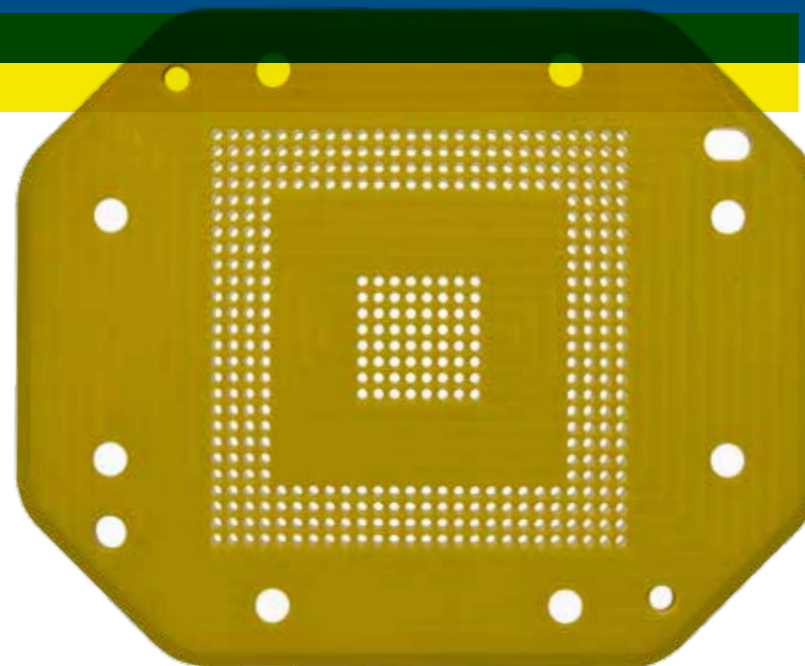

Processing methods

Precision components made of TECASINT are produced in small production runs using machining processes in accordance with customer drawings. For larger volumes, components can be cost-effectively pressed and sintered using the direct forming process.

TECASINT is available as:

- Stock shapes
(rods, plates, short tubes, discs)
- Machined parts
- Serial parts using the direct forming process

TECASINT – high-temperature polyimides for special applications

Glass industry

The use of polyimides can enhance productivity in the manufacture of glass bottles for the beverage, pharmaceutical and cosmetics industry. Their excellent temperature resistance and low thermal conductivity lend these high-performance plastics key benefits, particularly for hot glass handling, compared to components made of graphite. They also help extend the service life of components and reduce the reject rates. In addition, these materials are economical to process, making them an ever more popular alternative for the production of take-out tongs and bottle grippers.

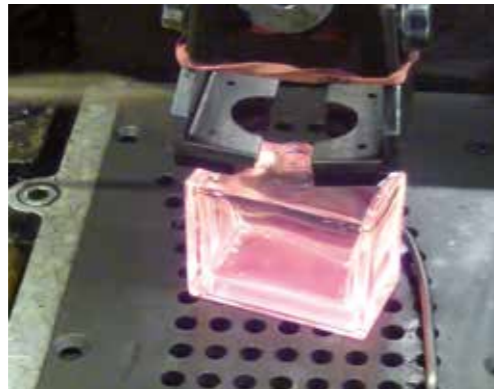

Electrical/electronics and semiconductor industry

Alongside its excellent electrical insulation, TECASINT also offers a very low ion content, making it ideal for use in the semiconductor industry and in cleanroom environments, for example in test sockets or in chip and wafer manufacture.



Aerospace industry

Low outgassing rates, high purity and good mechanical properties are key requirements in the manufacture of satellites. Excellent tribological properties, a long service life and low wear are essential criteria for the production of bearing bushes used in modern aircraft engines. TECASINT is the ideal material to address all these needs.



Automotive industry

Due to the TECASINT property profile, these materials are frequently superior to other plastics and metals. They can be used to implement applications involving the most extreme conditions, and are used for applications in the automotive industry requiring mechanical stability under high continuous temperatures or high pV values in lubricated and unlubricated environments. Use of the direct forming method allows the economical manufacture of serial parts complying with the narrowest of tolerances.

Mechanical engineering, vacuum technology and cryotechnology

The fields of application are widely varied: in mechanical engineering applications, the excellent sliding properties of graphite or graphite/PTFE-modified TECASINT types are the preferred choice. In vacuum technology and cryogenic applications, unreinforced or MoS₂ modified types are used for sliding applications.

Product families stock shapes

TECASINT 1000

- Very high modulus
- High rigidity and hardness
- Previous designation: SINTIMID

TECASINT 2000

- Very high modulus
 - High rigidity
 - High hardness
- Compared to TECASINT 1000, significantly reduced moisture absorption. Higher toughness and improved machining capability. Ideally suited for direct forming components.

TECASINT 4000

- Compared to the other TECASINT materials, TECASINT 4000 is characterized by the following properties:
- Minimal water absorption
 - Highest heat ageing resistance
 - Low friction and wear
 - Optimum chemical resistance
 - HDT/A up to 470 °C
 - Different types available with high elongation at break and toughness or with high flexural modulus

TECASINT 5000

- Cost-effective materials
- Extremely good dimensional stability and load capacity up to 300 °C

TECASINT 8000

- Matrix of PTFE reinforced with PI powder
- Reduced creep under load
- Excellent sliding and friction properties
- Ideally suited for soft sliding partners (stainless steel, aluminium, brass, bronze)
- Best chemical resistance and easy machining properties

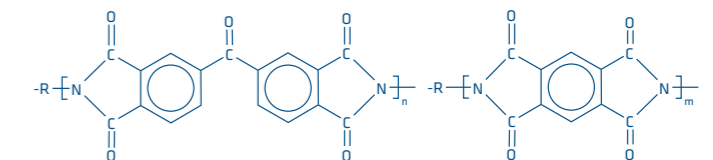

Structural formula PI

Clip
TECASINT 2011 (PI):
High purity.
Very good machinability.



Sensor housing
TECASINT 5011:
Thermal resistance up to 300 °C.
Very good electrical insulation.

Modifications

Unfilled

- Maximum strength and elongation
- Highest modulus
- Minimal thermal and electrical conductivity
- High purity
- Low outgassing in vacuum in accordance with ESA regulation ECSS-Q-70-20

+ 15 % graphite

- Enhanced wear resistance and thermal ageing
- Self lubricating, for lubricated and unlubricated applications

+ 40 % graphite

- Reduced thermal expansion
- Maximum creep strength and resistance to thermal ageing
- Improved self-lubrication
- Reduced strength

+ 15 % graphite / + 10 % PTFE

- Extremely low static friction and low coefficient of friction due to PTFE modification
- Good properties also in dry running conditions due to self lubrication
- For applications involving low friction and wear characteristics at medium temperatures and loads (< 200 °C)

+ 15 % MoS₂

- Best friction and wear properties in vacuum
- Frequently used in space applications, in vacuum or in inert gases (techn. dry)
- Low outgassing in vacuum in accordance with ESA regulation ECSS-Q-70-20

+ 30 % glass fibres

- Reduced thermal expansion
- High thermal-mechanical load properties
- Excellent electrical insulation

SD

- Static dissipative / antistatic, permanently migration free
- Surface resistance 10⁶⁻⁸ Ω oder 10¹⁰⁻¹² Ω
- For explosion-proof equipment and in semi-conductor technology (test sockets)

Overview of modifications

Description	Nomenclature Stock shape	Availability TECASINT					Modifications	8000
		1000	2000	4000	4100	5000		
Pure	x011	1011	2011	4011	4111	5111	80 P / 20 PI	8001
15 % graphite	x021	1021	2021	4021	4121	-	85 P / 15 PI	8061
40 % graphite	x031	1031	2031	-	-	-		
15 % graphite / 10 % PTFE	x061	1061	2061	-	-	-		
15 % MoS ₂	x391	-	2391	-	-	-		
30 % GF	x051	-	-	-	-	5051		
SD static	x501	-	-	-	-	5501		
SD dissipative	x511	-	-	-	-	5511		

Customized products available on request.

Overview of nomenclature TECASINT

TECASINT xxxx

1st digit → PI basic material / product family

2nd + 3rd digit → Formulation code / modification

4th digit → Production process
(1 = stock shape, 2 = direct forming)

Direct forming process

Low-cost manufacturing method for high volume precision parts

Fast-running vertical automatic presses (mechanical or hydraulic) compress the powder in the die. The part geometry must permit the part to be ejected from the press die. Blanks are then sintered for a number of hours at high temperature. This causes a degree of shrinkage, which is accounted for in the original design of the die.

The following types are available for direct forming:

TECASINT 2000 DF

- TECASINT 2012 (unfilled)
- TECASINT 2022 (wear resistant grade)
- TECASINT 2032 (highly filled grade, low friction)
- TECASINT 2062 (15 % graphite, 10 % PTFE)

TECASINT 6000 DF

- TECASINT 6012 (unfilled)
- TECASINT 6022 (wear resistant grade)
- TECASINT 6032 (highly filled grade, low friction)
- TECASINT 6062 (15 % graphite, 10 % PTFE)

Conditions for direct forming

Min. part thickness	~ 1 mm
Max. part thickness	30 mm
Max. outside diameter	145 mm
Min. inside diameter	~ 2 mm
Surface quality	~ 1 μm (Ra)
Flattening at the chamfers	0.15 – 0.3 mm

Reference value

Applications:

Valve seats, sliding rails, chain guides, piston rings, guides, wear rings, axial sealing rings, shaft end seals, bearing discs, bearing bushes, collar bushes, sliding bearings, hot glass grippers

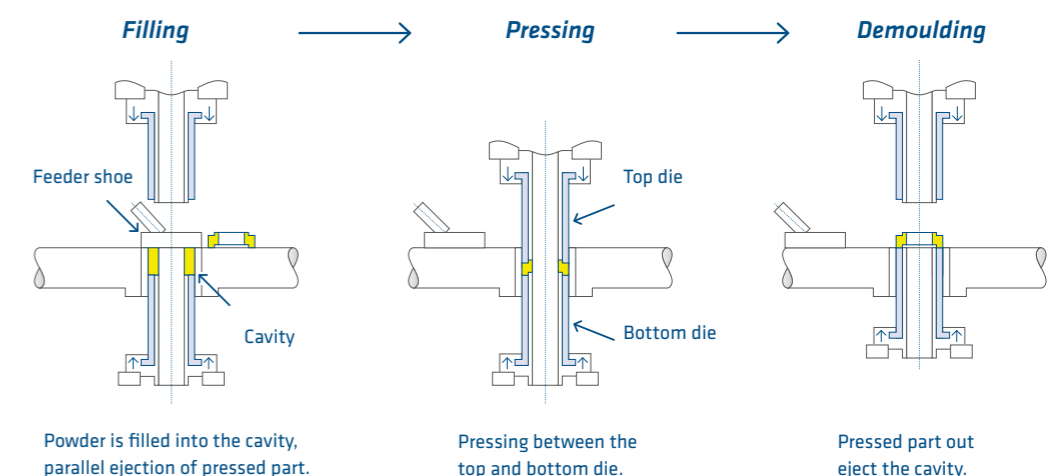

For more informationen regarding direct forming please have a look on our website: tecasint.com

Tolerance guideline for direct formed parts

Diameter		Height	
0 - 14 mm	± 0.030 mm	0 - 5 mm	± 0.10 mm
15 - 30 mm	± 0.050 mm	5 - 15 mm	± 0.20 mm
31 - 60 mm	± 0.075 mm	15 - 40 mm	± 0.25 mm

Reference value

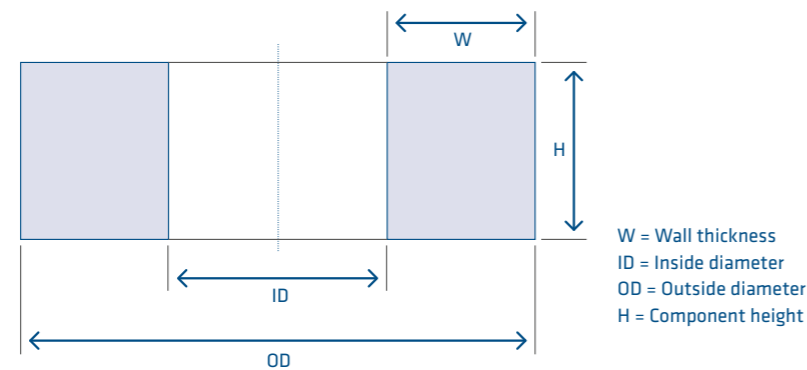

Diameter	Concentricity	Roundness	Parallelity	Flatness
0 - 25.4 mm	0.04	0.050	0.040	0.050
25.4 - 50.8 mm	0.05	0.125	0.075	0.125
> 50.8 mm	0.05	0.125	0.075	0.125

All values in [mm]

Reference value

Shape and position tolerances can be manufactured off-tool. Depending on the part geometry and component size, deviations to the listed tolerances are possible. Consequently, tolerances have to be considered individually for each component. Undercuts and transverse holes, which cannot be manufactured off-tool, and also narrow tolerances can be realized by a subsequent machining operation.

General design guidelines

- No undercuts possible
- Collar bushes require a radius between the flange and hub
- A minimum wall thickness of 1 mm is recommended
- The wall thickness is a function of the part height. This depends on the material and should not exceed the value of 1:10

- Bevelled edges up to an angle of 30 degrees starting from the horizontal level are possible, but need to be integrated into the female die
- Larger phase angles require flattening by 0.15 mm to 0.3 mm around the die periphery
- Flattening (appr. 0.15 mm – 0.3 mm) is required at the base of all 45 – 60 degree phases
- When pressing on one level, grooves can still be demoulded up to a depth of max. 30% of the part height, but should have a demoulding incline of 1 degree on both sides
- Holes should be at least 2 mm in diameter

Seal rings

Seal rings made of TECASINT are suitable for continuous application temperature ranges of -270 °C to +300 °C. Compared to seal rings made of metal, they offer greater yield, and their higher degree of elasticity makes them more resistant to permanent deformation.

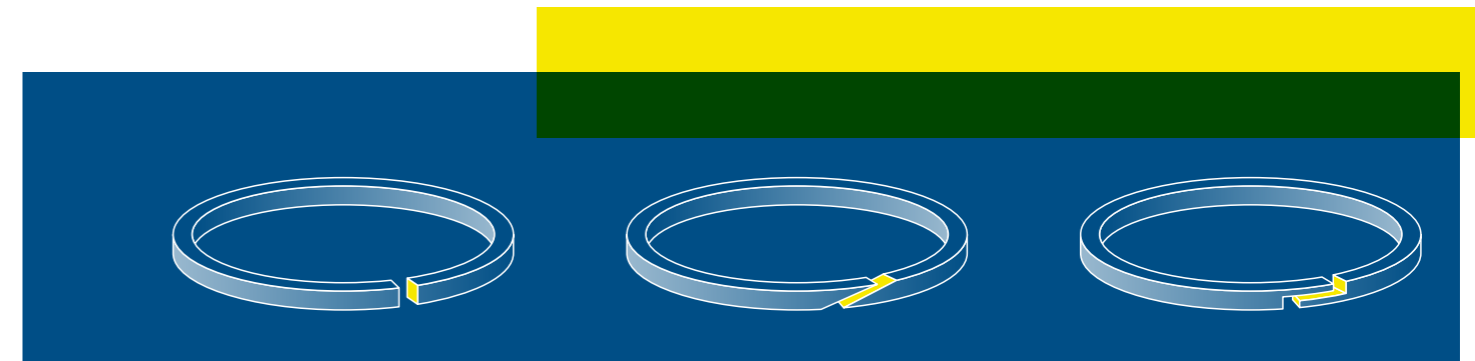

Butt joint

- Direct formable
- Gap closes when heated and response to pressure without permanent deformation
- Low-cost solution rings with very low constant leakage rates
- Minimum oil pressure required for even contact pressure on the groove flanks
- Maximum wall thickness for straight butt joint sealing rings: 0.5 x (min. shaft diameter – groove base diameter) – 0.05 mm

Scarf joint

- Direct formable with subsequent finish machining
- Joint customarily with 20 degree
- Gap clearance effect far lower than with butt joint
- Seal effect less dependent on minimum oil pressure

Stepped joint

- Direct formable with subsequent finish machining
- Stepped joint seal created by media pressure at any application temperature
- Behaves on principle in the same way as a butt joint connection with slightly reduced clearance
- Rings with very low constant leakage rates
- Seal less dependent on minimum oil pressure

Mechanical properties

The determination of mechanical properties by tensile testing provides information about stress-strain behaviour and the resulting modulus. As components made of TECASINT are only seldom used at room temperature, material behaviour at elevated service temperatures is required for successful component design. Even at high temperatures where conventional thermoplastic materials would fail or disintegrate, TECASINT polyimides are characterized by very high strength and modulus levels.

Tensile Test TECASINT types at 23 °C / 73 °F

EN ISO 527

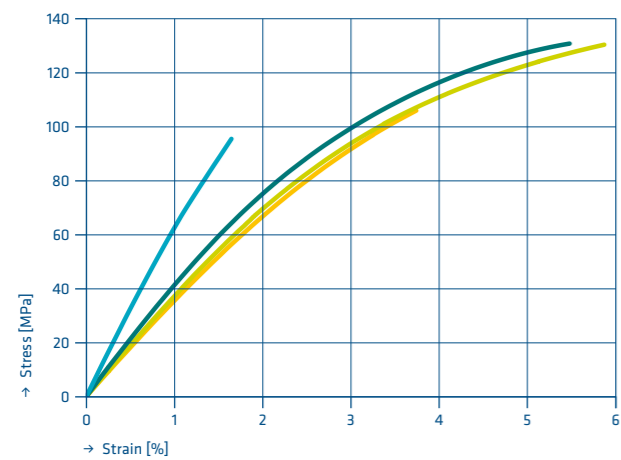

TECASINT 1011 TECASINT 2011
TECASINT 4011 TECASINT 4111

Tensile Test TECASINT types at 260 °C / 500 °F

EN ISO 527

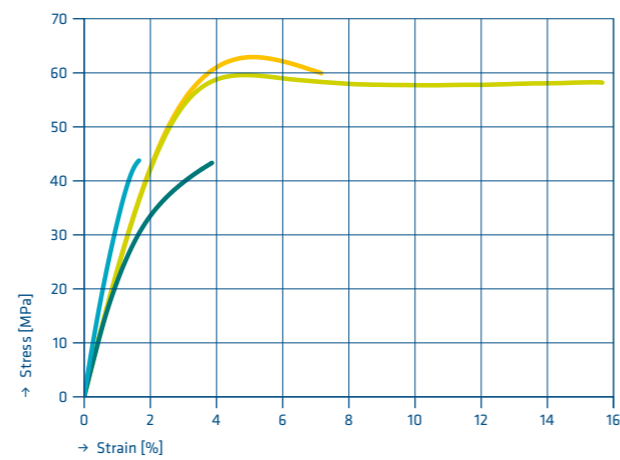

TECASINT 1011 TECASINT 2011
TECASINT 4011 TECASINT 4111

Tensile Modulus [MPa]

EN ISO 527

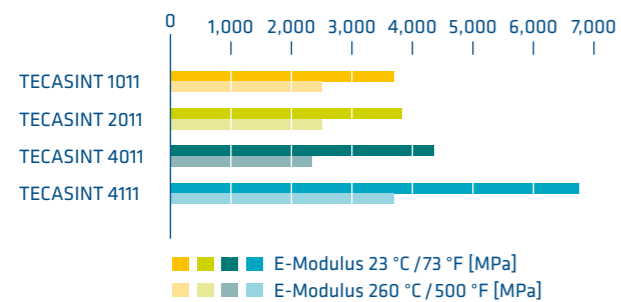

E-Modulus 23 °C / 73 °F [MPa]
E-Modulus 260 °C / 500 °F [MPa]

Dynamic Mechanical Analysis (DMA)

DMA measurement is defined as the mechanical response behaviour (storage modulus E' and loss factor $\tan \delta$) of a material exposed to minimal oscillating load. Measured values are recorded on a time, temperature and frequency-

dependent basis. The storage modulus E' constitutes the proportion of rigidity which allows the energy of a mechanical load to be stored by the material as a result of elastic deformation and then given off again.

Storage modulus E' as function of temperature

DMA, 3-point bending test, 1 Hz, 2 K/min

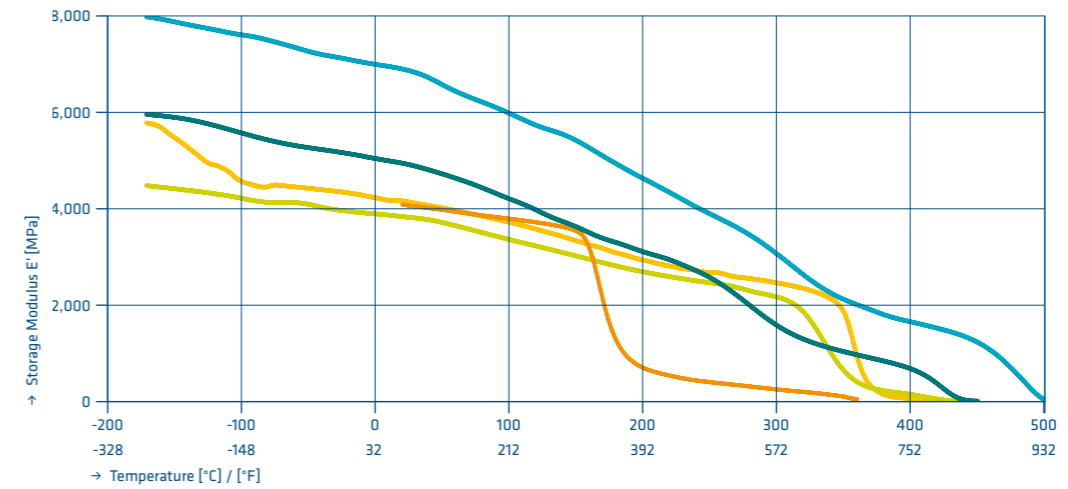

TECAPEEK TECASINT 1011 TECASINT 2011
TECASINT 4011 TECASINT 4111

Creep strength

Creep strength is the term given to the deformation increase depending on time and temperature under a constant load. TECASINT is a non-melting material which does not soften even under the influence of high temperatures

and demonstrates very low creep tendency under load. The diagrams below demonstrate the creep modulus and creep strain depending on time and temperature under a load of 17 MPa.

Creep Strain TECASINT at 23 °C / 73 °F

17 MPa, ISO 899-1

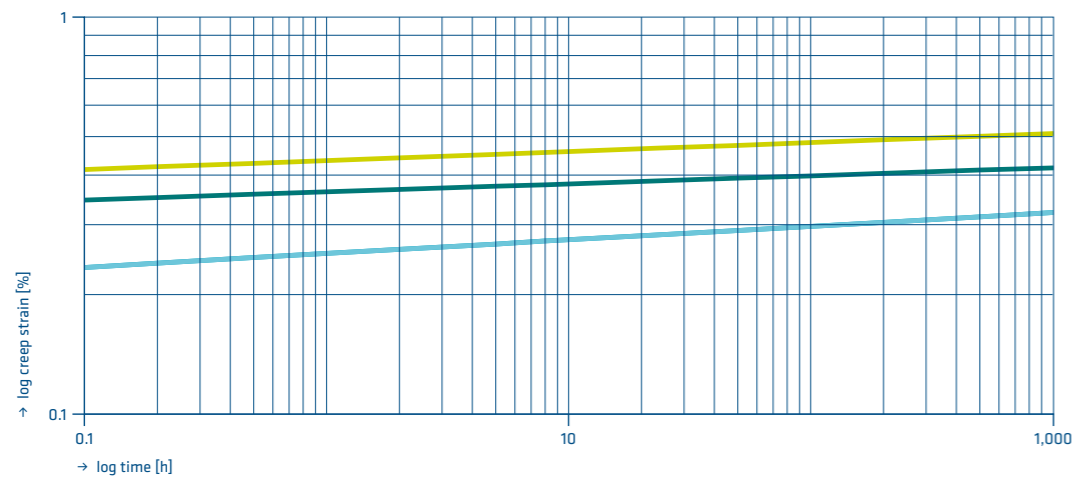

TECASINT 2011 TECASINT 4011 TECASINT 4111

Creep Strain TECASINT at 150 °C / 302 °F

17 MPa, ISO 899-1

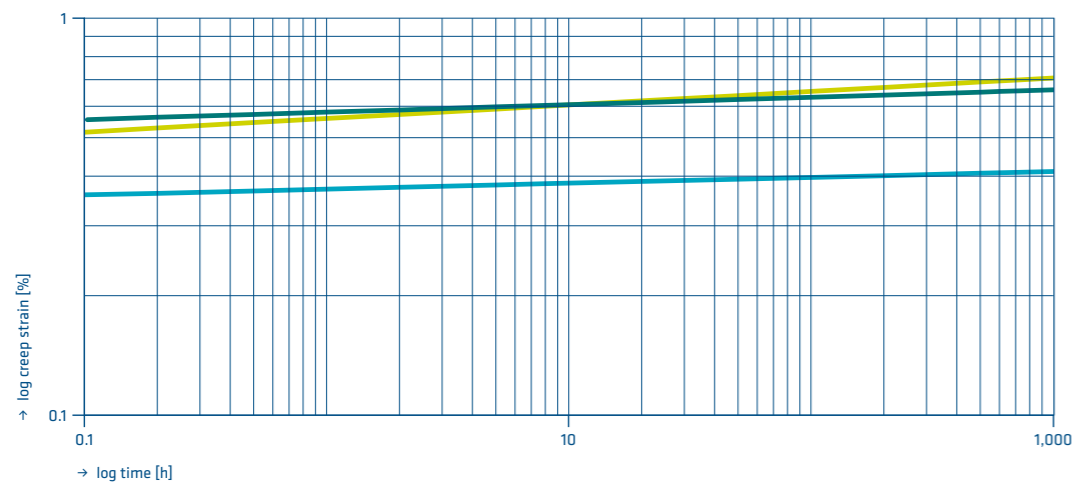

TECASINT 2011 TECASINT 4011 TECASINT 4111

Creep Strain TECASINT at 250 °C / 482 °F

17 MPa, ISO 899-1

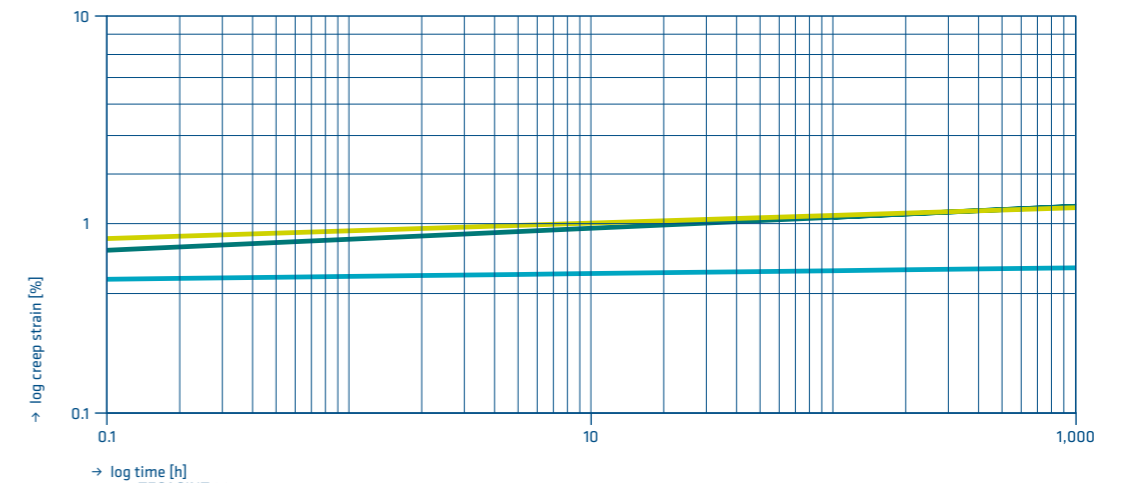

TECASINT 2011 TECASINT 4011 TECASINT 4111

Creep modulus E_c TECASINT at 150 °C / 302 °F

17 MPa, ISO 899-1

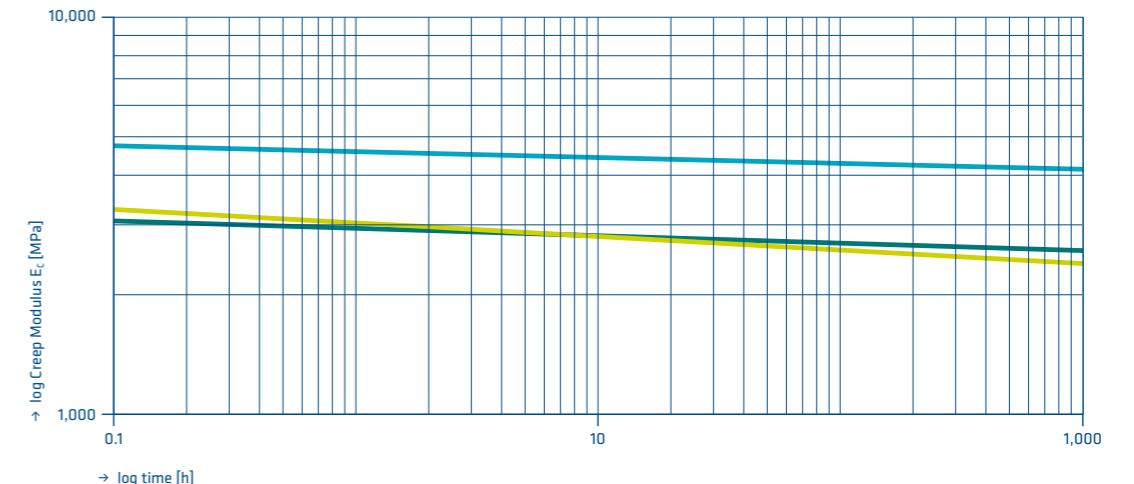

TECASINT 2011 TECASINT 4011 TECASINT 4111

Thermal properties

Due to their chemical structure and infusibility, polyimides are far superior to thermoplastics for use in high temperature applications. By ascertaining their thermal oxidation stability, a guideline can be seen for service life and ageing resistance under thermal load.

Thermal Oxidation Stability at 300 °C / 572 °F 4.8 bar for 300 hours

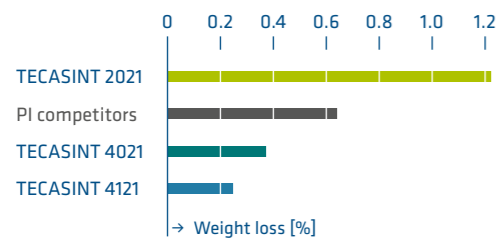

Here, TECASINT 4000 materials demonstrate their excellent properties with minimal weight loss at 300 °C and with additional pressure of 4.8 bar.

Ageing resistance in air at 340 °C / 644 °F

Long-term tests performed at 340°C in air testify to the excellent properties of TECASINT 4000. After 2,000 hours, TECASINT 4011 still attains 50% of its original flexural strength.

Heat Distortion Temperature HDT / A 1.80 MPa

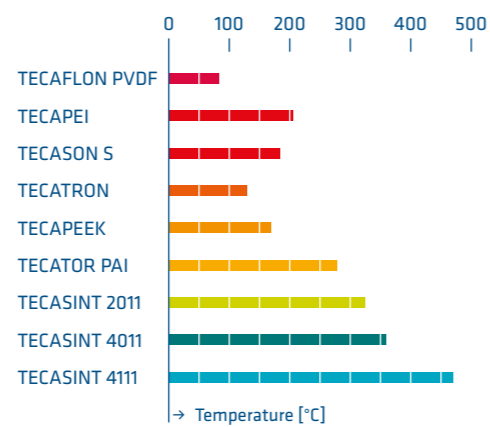

With its residual flexural strength of 70% after 3,100 hours, TECASINT 4111 sets the benchmark for extreme high-temperature applications.

Ageing curve, max. flexural strength at 340 °C / 644 °F oven storage

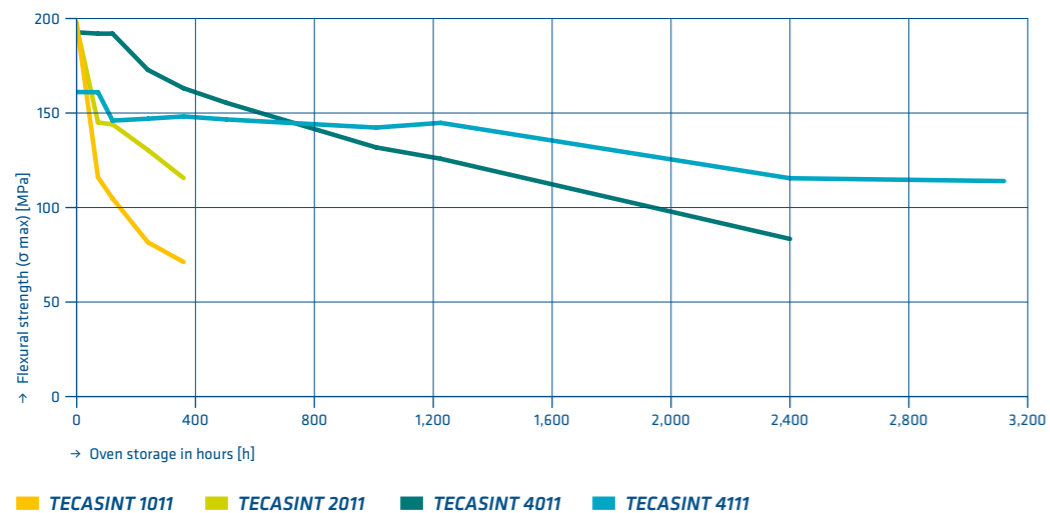

Electrical properties

Due to their excellent electrical insulating properties, high strength and very good radiation and thermal resistance, components made of TECASINT are ideally suited for electrical applications under difficult conditions. Even at high temperatures, they do not lose their

electrical properties. With rising moisture content, the dielectric loss factor and the dielectric constant both increase. The surface and volume resistance are only minimally influenced by increasing moisture content.

Tribological properties

TECASINT polyimides benefit from high abrasion resistance and are ideally suited for applications involving minimum lubrication or dry running. For tribological requirements, types containing graphite or graphite/PTFE modifications are used, while in vacuum applications, molybdenum disulphide (MoS₂) is used.

The tribological characteristics depend heavily on the ambient conditions. Factors such as sliding speed, load and form of movement (linear, oscillating, rotating) exert a major influence. Because of these complex correlations,

the coefficient of friction and wear always have to be considered in the light of the test system used. This makes it almost impossible to provide precise values for each application, so that testing under practical conditions is essential.

Shaft-Bushing-Test after 72 hours pV = 10.000 (Rpm: 1278 / 30 psi)

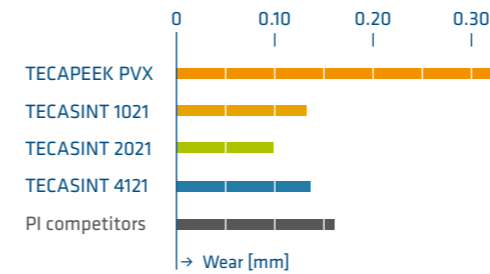

Ball-Prism-Test, Steel 100Cr6 Unlubricated, F = 30 N, n = 60 1/min

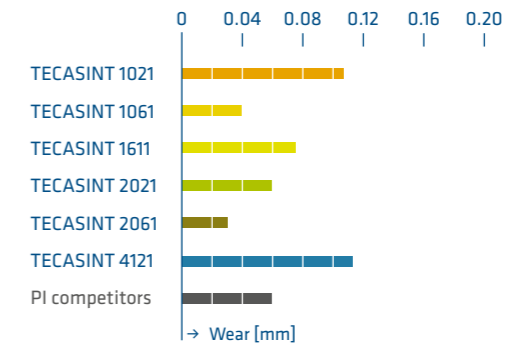

Behaviour under environmental influences

TECASINT components are often exposed to wide-ranging different environmental influences which may result in property changes in the polymer. The combination of different environmental influences results in unpredictable reciprocal effects. It is only by testing under practical conditions that this type of influence can be simulated.

Water absorption ISO 62 at 23 °C / 73 °F [%]

EN ISO 62 (in water)

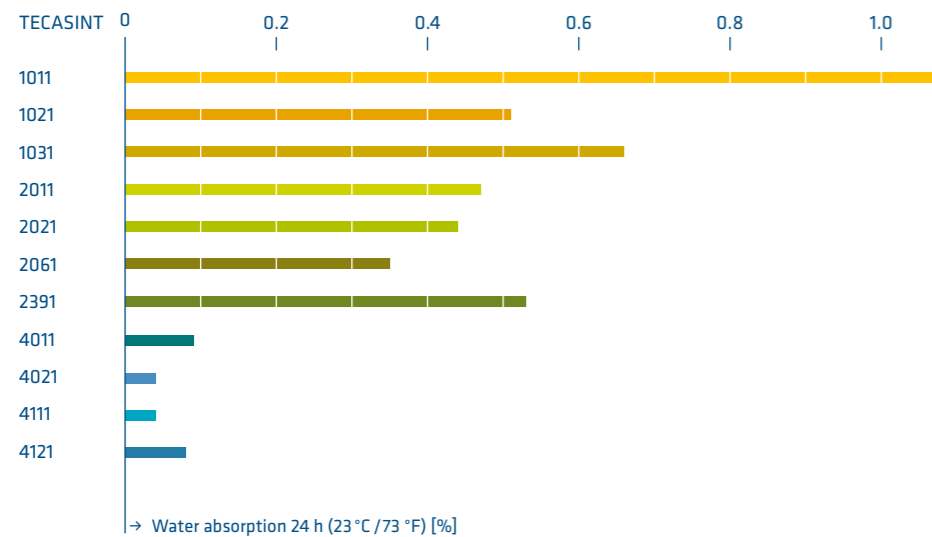

Drying

Like many other plastics, TECASINT also demonstrates hygroscopic behaviour. This means that the plastic is able to absorb water, generally in the form of air humidity. This absorption of moisture is reversible, i.e. the absorbed water can be fully removed again by drying.

When producing components with very low tolerances, however, it can make sense to dry TECASINT prior to machining, in order to remove any residual moisture and ensure that the parts are conditioned to a uniform starting status. The dried finished parts then have to be packaged in an airtight sealable PE bag.

When manufacturing high-precision components, we therefore recommend drying the parts prior to machining in order to eliminate the disturbing influence of water. Even components with an application temperature of over 200 °C should be dried in order to prevent the formation of bubbles in the material as a result of vapour pressure.

Drying process

- Store the component for at least 48 hours at 150 °C
- Then heat to 240 °C within 8 hours and leave to dry for at least 24 hours at this temperature
- Switch off the oven and leave to cool slowly

Annealing

Due to the sintering process, semi-finished and machined parts made of TECASINT are almost stress free and have low warping tendencies, meaning that they do not require annealing.

Hydrolysis

Polyimides are sensitive to hydrolysis at temperatures > 100 °C and are consequently not suitable for use in hot water, steam or for repeated steam sterilization processes.

Flammability and weather resistance

Flammability

Oxygen index LOI in accordance with EN ISO 4589-2

The “Limiting Oxygen Index” (LOI) indicates the minimum oxygen concentration which must prevail in an oxygen/nitrogen mix when a material burns. TECASINT will only burn with an oxygen content of around 50 % and is consequently not burning in normal air with an oxygen content of only 21 %.

Oxygen index LOI

EN ISO 4589-2

	LOI
TECASINT 2011	51
TECASINT 4011	49
TECASINT 4111	52

Weather resistance

Polyimides are highly radiation resistant. To assess weather resistance, Xenotest weathering in compliance with EN 4892 was selected. This simulates not only radiation with artificial sunlight but also regular rain cycles to test the influence of rain, humidity and temperature in natural weathering. The TECASINT 4000 types emerged particularly well from these tests, demonstrating over 70 % of their flexural strength even after 5000 hours.

Flexural strength after weathering

Xenotest, DIN EN ISO 4892-2

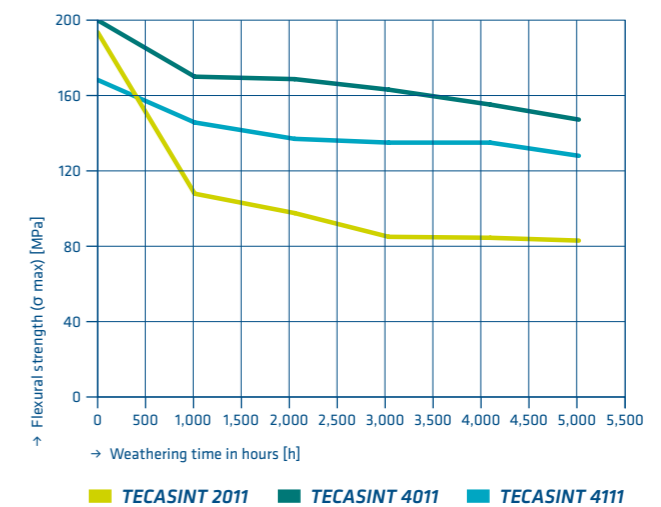

Chemical resistance

TECASINT products offer a high level of resistance to many chemical substances, including organic and inorganic solvents, fuels, oils and synthetic lubricants. TECASINT products are susceptible in combination with water and water vapour above 100 °C. Due to their hydrolysis susceptibility, marked cracks can occur here. Important criteria for testing

chemical resistance are temperature, concentration of agents, exposure time and mechanical load. In the table below, resistance to different substances is listed. This overview is provided as an aid to orientation. For specific applications, customers are advised to perform their own verification tests.

Chemical resistance of TECASINT (PI)

Acetone	+	Iodine solution, alcohol solution	+	Hydrochloric acid, aqueous solution 36 %	-
Formic acid, aqueous solution 10 %	+	Potassium lye, aqueous 50%	-	Hydrochloric acid, aqueous solution 2 %	+
Ammonia solution 10 %	-	Potassium lye, aqueous 10%	(+)	Sulphur dioxide	+
Benzine	+	Potassium dichromate, aqueous solution 10 %	-	Sulphuric acid, concentrated 98 %	-
Benzene	+	Potassium permanganate, aqueous solution 1 %	+	Sulphuric acid, aqueous solution 2 %	+
Bitumen	+	Cupric sulphate, 10 %	+	Soap solution, aqueous solution	(+)
Butyl acetate	+	Linseed oil	+	Silicone oils	+
Calcium chloride, solution 10 %	+	Methanol	+	Soda solution, aqueous solution 10 %	(+)
Chlorobenzene	+	Methyl ethyl ketone	+	Edible fats, Edible oils	+
Chloroform	+	Methylene chloride	+	Styrene	+
Cyclohexane	+	Milk	+	Tar	+
Cyclohexanone	+	Lactic acid, aqueous solution 90 %	+	Carbon tetrachloride	+
Dekalin	+	Lactic acid, aqueous solution 10 %	+	Tetrahydrofurane	+
Diesel oil	+	Sodium bisulphite, aqueous solution 10 %	+	Tetralin	+
Dimethyl formamide	(+)	Sodium carbonate, aqueous solution 10 %	(+)	Ink	+
Dioxane	+	Sodium chloride, aqueous solution 10 %	+	Toluene	+
Acetic acid, concentrated	(+)	Sodium nitrate, aqueous solution 10 %	+	Transformer oil	+
Acetic acid, aqueous solution 10 %	+	Sodium thiosulphate 10 %	+	Triethanolamine	-
Acetic acid, aqueous solution 5 %	+	Soda lye, aqueous 50 %	-	Trichlorethylene	+
Ethanol 96 %	+	Soda lye, aqueous 5 %	(+)	Trilon B, aqueous solution 10 %	+
Ethyl acetate	+	Nitrobenzene	+	Vaseline	+
Ethyl ether	+	Oxalic acid, aqueous solution 10 %	+	Wax, molten	+
Ethylene chloride	+	Ozone	(+)	Water, cold	+
Freon, Frigen, liquid	+	Paraffin oil	+	Water, warm	-
Fruit juices	+	Perchlorethylene	+	Hydrogen peroxide, aqueous solution 30 %	-
Glykol	+	Petroleum	+	Hydrogen peroxide, aqueous solution 0.5 %	+
Glycantine, aqueous solution 40 %	+	Phenol, aqueous solution	+	Wine, Brandy	+
Glycerine	+	Phosphoric acid, concentrated	(+)	Tartaric acid	+
Urea, aqueous solution	+	Phosphoric acid, aqueous solution 10 %	(+)	Xylene	+
Heating oil	+	Propanol	+	Zink chloride, aqueous solution 10 %	+
Heptane, Hexane	+	Pyridine	-	Citric acid, aqueous solution 10 %	+
Iso-octane	+	Salicylic acid	+		
Isopropanol	+	Nitric acid, aqueous solution 2 %	+		

+ resistant (+) limited resistance - not resistant
(also dependent on concentration, time and temperature)

Purity

In ultra-clean production environments such as in the semi-conductor and solar industry, foreign ions can result in contamination and higher reject rates.

Ionic purity

The TECASINT materials can be classed in the "high purity" category.

Outgassing

Tests in compliance with the ESA regulation indicate no condensable impurities in TECASINT. These products can consequently be used in high vacuum / space applications.

Low outgassing

according to ESA regulations ECSS-Q-70-02

Pur	1011	2011	4011	4111	4111
15 % MoS ₂		2391			

Ionic purity

[mg/kg] ↓	TECASINT 2011	TECASINT 4011	TECASINT 4111
Aluminum (Al)	1	<1	<1
Calcium (Ca)	1	<1	<1
Copper (Cu)	<0.1	<0.1	<0.1
Iron (Fe)	0.43	0.24	0.21
Magnesium (Mg)	<2	<2	<2
Sodium (Na)	<3	<3	<3
Zinc (Zn)	<0.3	<0.3	<0.3

Test socket
TECASINT 5011:
Thermal resistance up to 300 °C.
High strength.
Good electrical insulation.

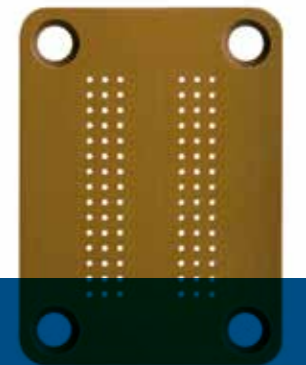

Contact plate
TECASINT 5051:
Low thermal expansion.
Thermal resistance up to 300 °C.
Wear resistant.

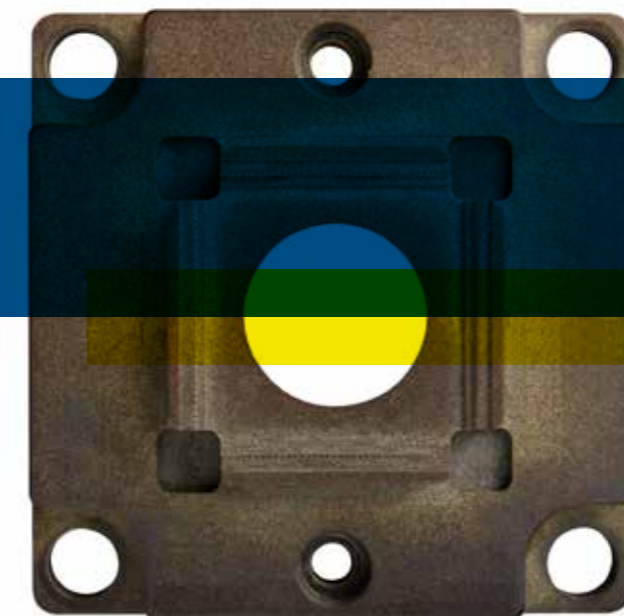

FAQs

What benefits does TECASINT offer when producing bushings and slide bearings?

TECASINT offers an unusual characteristic profile permitting applications for components exposed to extreme levels of stress which cannot be achieved using other materials such as ceramics, metal or conventional plastics. Bushings and slide rings made of TECASINT remain tough, abrasion and creep resistant over a continuous application temperature of $-270\text{ }^{\circ}\text{C}$ to $300\text{ }^{\circ}\text{C}$, and often exceed the performance of other bearing materials.

How do TECASINT sliding bearings behave in comparison to needle and roller bearings?

Due to their good tribological characteristics, no external lubrication is required. Applications are possible in temperature ranges at which lubricants are ineffective. Good functionality in dirty environments. Noise, weight and cost reduction.

How do the wear properties compare with bronze, brass and sintered metal?

Extended life of other components due to marked reduction in wear compared to metal-to-metal mating. Reliable functionality in applications where unlubricated metals fail as a result of combined pressure, heat and surface speed. Impact and creep resistant. No problems due to lubricant loss where textile or paper dust are produced.

How do slide bearings made of TECASINT compare to other plastic bearings?

Applications possible at pressure levels, surface speeds and temperature ranges where technical thermoplastics are unable to function. Higher impact, compression and creep strength. Very high abrasion resistance. Very good cutting properties and lower tolerances are possible.

Sintered parts compared to extruded semi-finished products:

Pressing

- Semi-finished part geometries close to finished measurement
- Extreme economy due to material savings
- Low tendency to warp due to almost isotropic characteristics
- Consequently also easier to machine
- Discontinuous production process
- High semi-finished product costs

Extrusion

- Continuous production process
- Lower semi-finished product costs
- High tension levels due to orientations during production
- More difficult to machine

Machining guidelines

General

TECASINT products can be machined wet or dry on all machine tools suitable for metal machining. The use of cutting tools made of carbide with a cutting angle for aluminium machining has proven the most successful for machining these materials. To avoid machining errors, it is important to recognize and replace worn out cutting tools in good time, and to follow the recommended cutting and

feed rates for the individual machining processes. Deformation as a result of excessively high clamping pressure, in particular when machining thin-walled parts, must be avoided. Preferably, clamping sleeves, clamping mandrels or vacuum clamping fixtures should be used. The use of four-jaw chucks is recommended. A higher number of jaws results in improved distribution of the clamping force.

Turning

For all machining steps, the use of carbide tools, of the type customary for machining aluminium, offers the best solution. The tip of the cutting tool should have a radius of between 0.2 and 0.4 mm. As a result of wet machining, the cutting pressure at the work-piece increases, which can give rise to increased burr formation. The service life of the cutting tools is substantially extended by wet machining. If all the essential machining instructions are taken into account during turning, high quality products with a good surface finish can be achieved during the machining of PAI / PI products ($R_a \geq 1.6$).

Cutting speed for face, longitudinal, cylindrical turning / grooving and parting off

$V = 100 - 130\text{ m/min.}$

$f = 0.05 - 0.25\text{ mm/rev.}$

Dimensional stability

For machined parts with extremely close tolerances, the material should preferably be machined dry due to its hygroscopic behaviour. However, in this case, attention should be paid to ensuring good heat dissipation during the machining operation. PI and PAI parts with large diameters tend to spring back slightly immediately after piercing due to the high cutting pressure. Consequently it is advisable to always produce these in the lower tolerance band. Semi-finished products for the manufacture of extremely precise parts must be annealed prior to machining. An additional intermediate annealing process is generally not required during machining. In order to prevent dimensional changes to the finished parts due to their hygroscopic behaviour, it is advisable to seal high-quality components in vacuum barrier film if they are expected to remain in storage for an extended period.

Do you have any other questions?

*Please do not hesitate to contact our technical service:
Markus Edelbauer: m.edelbauer@de.ensinger-online.com
or Ben Sin (Asia): s.ben@ensinger.com.sg*

Milling

Milling is performed exclusively using the downcut milling. For all machining steps, the use of carbide tools with the same cutting geometry as that customarily used for aluminium is the best solution. Individual grinding of tools can result in improved results with certain work steps. Dry and wet machining is possible. As a result of wet machining, the cutting pressure at the workpiece increases, which can give rise to increased burr formation. The service life of the cutting tools is substantially extended by wet machining. Excessive single-sided application of heat into the material should be avoided. Alternating two-sided machining is recommended as the preferable method.

Face milling:

$V = 90 - 100 \text{ m/min.}$

$f = 0.04 - 0.08 \text{ mm/tooth}$

Drilling

Carbide drill bits are recommended for machining PAI and PI materials. The exception to this is boreholes less than 1.5 mm dia. These should be produced exclusively using HSS drill bits which should be ground to a pointed angle of 120 degree. To counteract the effects of heat generation, adequate chip removal and wet machining are recommended for all drilling processes.

HM drill:

$V = 100 \text{ m/min.}$

$f = 0.02 - 0.1 \text{ mm/rev.}$

HSS drill:

$V = 15 - 40 \text{ m/min}$

$f = 0.02 - 0.1 \text{ mm/rev.}$

A comprehensive overview is provided at tecasint.com



Key facts at a glance

For detailed instructions on machining, we are pleased to provide our technical information sheet "Machining guidelines for TECASINT".

Bonding TECASINT

TECASINT components can also be bonded to each other or to other plastics, metals and elastomers. In order to ensure a good glue joint, the components must be matched precisely to each other. The contact surfaces should be

roughened in advance either mechanically or by blasting. Oils, greases and dirt must be removed using solvents. Suitable glues include adhesions glues based on epoxy resin, polyurethane, rubber or cyanacrylate.

Standard shapes dimensions

TECASINT semi-finished products are available as plates, rods and short tubes:

- Rods from $\varnothing 6 \text{ mm}$ to max. $\varnothing 100 \text{ mm}$, max. length 1,000 mm
- Plates from 5 mm to max. 100 mm thickness
- Maximum plate formats up to 300 x 1,000 mm (max. dimensions depend on type)

Extensive stocked range

- Fast and flexible: All product types and dimensions shown on the stock list are available immediately
- Large plate formats for high cutting efficiency

Cutting service

- This is a cost-effective alternative as there is no need to buy complete plates or rods (low capital tie-up)
- A convenient option permitting need-driven order placement
- Fast availability. Generally within 2 - 3 days

Preferred dimensions can be found online at: www.goo.gl/upydXH



Machined parts
TECASINT 1000 - 4000 (PI):
Very high thermal stability.
High strength also at high temperatures.

Contact

Ensinger Sintimid GmbH
Ensingerplatz 1
4863 Seewalchen
Austria
Phone +43 7662 88788 0
tecasint@ensingerplastics.com
tecasint.com

Headquarter

Ensinger GmbH
Rudolf-Diesel-Straße 8
71154 Nufringen
Germany
Phone +49 7032 819 0
info@ensingerplastics.com
ensingerplastics.com



TECASINT is the Ensinger portfolio of non-melting high-temperature polyimides. Sintered TECASINT parts and shapes are used in numerous demanding industries.

ensingerplastics.com